

# Owner's Manual



► S337



► S3379



► S347



► S344

## Quick Reference Guide (S337)

1. Tiller
2. Control Panel
3. Tiller Adjustment Lever
4. Removable Seat
5. Adjustable Armrest
6. Rear Light
7. Free Wheel Lever
8. Anti-Tip Wheel
9. Seat Pivot Lever
10. Rug
11. Front Bumper
12. Headlight
13. Front Basket
14. Turn Signal
15. Seat Position Adjuster



Model No.	S337 (3-Wheels)	S3379 (3-Wheels)	S347 (4-Wheels)
Max. speed up to	12 kph / 7.5 mph ; 15 kph / 9.6 mph		
Range Up To	50 km / 32 mi		
Turning Radius	143 cm / 56.1 in	147 cm / 58 in	165 cm / 65 in
Ground Clearance	9 cm / 3.5 in		10 cm / 4 in
Motor	650W		
Controller	Rhino II 160A		
Battery	12V/group24 x 2PCS		
Charger	Max. 8A Off-board (Note)		
Gradient	10°		
Front Wheel	12"		
Rear Wheel	12"		
Brake	Intelligent, regenerative and electromagnetic brakes		
Overall Length	145 cm / 57 in	149 cm / 58.5 in	152 cm / 60 in
Overall Width	66 cm / 26 in		
Total Weight Without Batteries	82 kg / 180 lb		89 kg / 196 lb
Weight Capacity	227 kg / 500 lbs		
Battery Weight	25 kg / 55 lb (each)		

*This specification is for universal use and real spec may vary by regions and countries.  
Note : Depends on the specifications of the accompanied charger.*

## Quick Reference Guide (S344)

1. Tiller
2. Control Panel
3. Tiller Adjustment Lever
4. Removable Seat
5. Adjustable Armrest
6. Rear Light
7. Free Wheel Lever
8. Anti-Tip Wheel
9. Seat Pivot Lever
10. Rug
11. Front Bumper
12. Headlight
13. Front Basket
14. Turn Signal
15. Seat Position Adjuster



Model No.	S344 (4-Wheels)
Max. speed up to	15 kph / 9.6 mph
Range Up To	50 km / 32 mi
Turning Radius	165 cm / 65 in
Ground Clearance	10 cm / 4 in
Motor	650W
Controller	Rhino II 160A
Battery	Max. 8A Off-board (Note)
Charger	Off-board
Gradient	8°
Front Wheel	14"
Rear Wheel	14"
Brake	Intelligent, regenerative and electromagnetic brakes
Overall Length	152 cm / 60 in
Overall Width	66 cm / 26 in
Total Weight Without Batteries	99 kg / 218 lb
Weight Capacity	227 kg / 500 lbs
Battery Weight	25 kg / 55 lb (each)

*This specification is for universal use and real spec may vary by regions and countries.  
Note : Depends on the specifications of the accompanied charger.*

Welcome aboard your new Merits scooter. We wish to thank you for letting us improve your freedom and independence. This model has been designed with your practical needs in mind. It is equipped with modern high-tech electronics and special features for a more comfortable ride. Its safety and performance will provide you with years of excellent service and pleasure.

## Table of Contents

### Introduction

Practice before operating .....	3
---------------------------------	---

### Safety Instructions

Safety Considerations .....	5
Driving Outside .....	8
Driving on Hills .....	10

### Getting to Know Your Scooter

Parts of the Scooter .....	12
Charging the Batteries .....	13

### Operating Your Scooter

Parallel Tiller .....	14
Controls (Digital dashboard) .....	15
Controls (Analog dashboard) .....	18
Seat Adjustment .....	20
Tiller Angle Adjustment .....	21
Free Wheel Mode .....	21

Ice Symbols .....	22
-------------------	----

**Failure to follow these instructions may result in damage to the powerbase wheelchair or serious injury.**

## ■ Practice Before Operating

Find an open area such as a park and have an assistant to help you practice until you have confidence operating this vehicle.

Make sure that the power is off before getting in or out of the seat. Set the speed control button according to your driving ability.

**We recommend that you keep the speed control at the slowest position until you are familiar with the driving characteristics of this vehicle.**

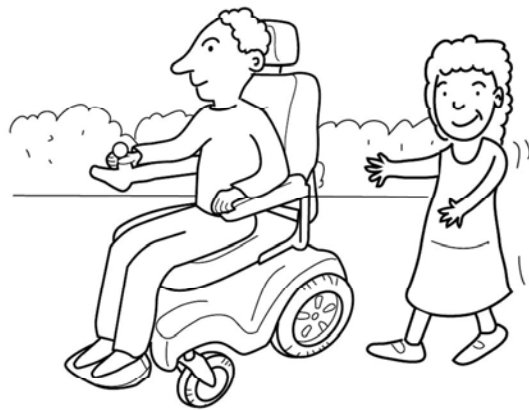

Stop, forward, and reverse operation practice

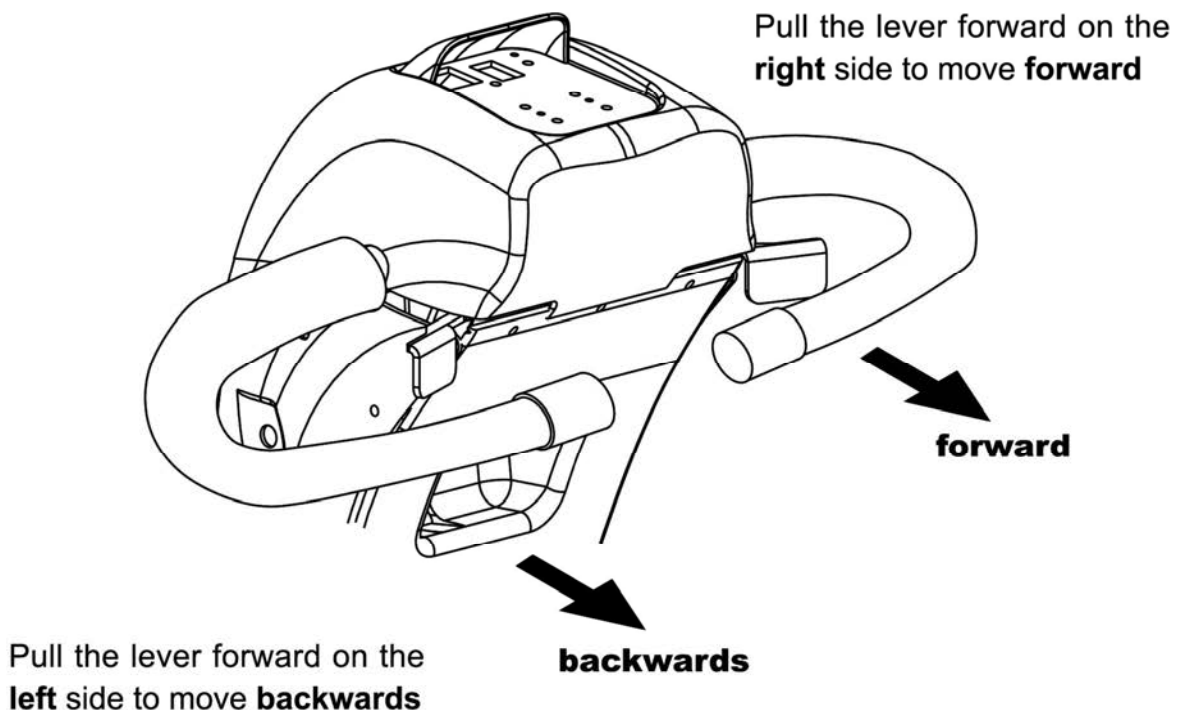

## Getting familiar with this vehicle



**First, practice moving forward.  
Be sure to set the speed to the lowest setting.**



**After becoming familiar with moving forward,  
practice marking "S" turns.**



**Once you are familiar with "S" turns, practice  
moving in reverse.**

## ■ Safety Considerations

**DO NOT** do any of the following



**NO!**

Do not carry any passengers



**NO!**

Do not drive across a slope



**NO!**

Do not drink and drive

Consult your physician to determine, if your medications impair your ability to control this vehicle



**NO!**

Do not tow a trailer



**NO!**

Do not turn on or use hand-held personal communication devices such as citizens band (CB) radios and cellular phones

This vehicle has an immunity level of 20 V/m which should protect it from Electromagnetic Interference(EMI) from Radio Wave Sources. The rapid development of electronics, especially in the area of communications, has saturated our environment with electromagnetic (radio) waves that are emitted by television, radio and communication signals. These EM waves are invisible and their strength increases as one approaches the source. All electrical conductors act as antennas to the EM signals and, to varying degrees, all power wheelchairs and scooters are susceptible to electromagnetic interference (EMI). This interference could result in abnormal, unintentional movement and/or erratic control of the vehicle. The United Statement be incorporated to the user's manual for all electric scooter.

Powered wheelchairs and electric scooters(in this text, both will be referred to as powered wheelchairs) may be susceptible to electomagnetic interference(EMI), which is interfering electromagnetic energy emitted from sources such as radio stations, TV stations, amateur radio (HAM) transmitters, two-way radios and cellular phones. The interference (from radio wave sources) can cause the powered wheelchair to release its brakes, move by itself or move in unintended directions. It can also permanently damage the powered wheelchair's control system. The intensity of the EM energy can be measured in volts per meter (V/m). Each powered wheelchair can resist EMI up to a certain intensity. This is called the "immunity level." The highedr the immunity level, the greater the protection. At this time, current technology is capable of providing at least 20 V/m of immunity level which would provide useful protection against common sources of radiated EMI.

Following the warnings listed below should reduce the chance of unintended brake release or powered wheelchair movement that could result in serious injury:

- 1) Do not turn on hand-held personal communication devices such as citizens band (CB) radios and cellular phones while the powered wheelchair is turned on.
- 2) Be aware of nearby transmitters such as radio or TV stations and try to avoid coming close to them.



- 3) If unintended movement or brake release occurs, turn the powered wheelchair off as soon as it is safe.
- 4) Be aware that adding accessories or components, or modifying the powered wheelchair, may make it more susceptible to interference from radio wave sources. (Note: there is no easy way to evaluate their effect on the overall immunity of the powered wheelchair).
- 5) Report all incidents of unintended movement or brake release to the powered wheelchair manufacturer, and note whether there is a radio wave source nearby.

**TURN OFF YOUR SCOOTER AS SOON AS POSSIBLE WHEN EXPERIENCING ANY OF THE FOLLOWEING:**

1. Unintentional motions.
2. Unintended or uncontrollable direction.
3. Unexpected brake release.

The FDA has written to the manufacturers of power wheelchairs, asking them to test their new products to be sure they provide a reasonable degree of immunity against EMI. The letter says that powered wheelchairs should have an immunity level of at least 20 V/m, which provide a reasonable degree of protection against the more common sources of EMI. The higher the level, the greater the protection.

## ■ Driving Outdoors

When you are on the road, please pay attention to the following:



**NO!**

Do not drive in traffic.



**NO!**

Do not drive beside a river, port, or lake without a fence or railing.



**NO!**

If possible, do not drive during the rain.



**NO!**

If possible, do not drive during or on snow.



**NO!**

Do not drive off-road or on any uneven surfaced roads.



**NO!**

If possible, do not drive at night.



**NO!**

Make sure that there are no obstacles behind you when in reverse.

We recommend to set the speed knob at the lowest speed for reversing.



**NO!**

Do not make sudden stops, weave erratically, or make sharp turns.



**NO!**

Keep your arms on or inside the armrests and feet on the footrest at all time.



**NO!**

Do not attempt to climb curbs greater than 2"(5cm).

2"(5cm)



**NO!**

Do not attempt to cross over a gap greater than 4"(10cm).

Gap greater 4"(10cm)

■ Use caution when driving on hills

Driving on hills is more dangerous than on level surfaces. If you fail to heed these warnings, a fall, tip-over or loss of control may occur and cause severe injury to the vehicle user or others.



**NO!**

Do not attempt to climb a hill greater than 10°



**NO!**

Do not reverse while driving up a hill.

Forward only. If you reverse while moving up a hill, it may cause the vehicle to tip over.



**NO!**

Do not attempt to drive across a sloping surface greater than 3°

Driving across a slope greater than 3° is very dangerous and may cause the vehicle to tip over.



**NO!**

Use caution when driving over soft, uneven or unprotected surfaces such as grass, gravel and decks.



**NO!**

**Use low speed while driving down hill.**

When going down hill, the tiller will become harder to reach and handle. When braking while moving down hill, the scooter will take longer to come to a complete stop.



**NO!**

**Do not get in and off on a hill.**

Always stop on the level surface to get in and get out of the vehicle.



**NO!**

**Do not load or carry heavy items in the basket while driving down hill.**



**YES!**

**Always climb or descend gradients perpendicular to the slope or ramp.**

In this section, we will acquaint you with the many features of your scooter and how they work. Upon receipt of your scooter, inspect it for any damage. Your scooter consists of a frame assembly, drivetrain assembly, seat assembly, tiller assembly, battery charger, and owner's manual. Contact your sales agent if any question arise.

## FEATURE GUIDE (S347)



- |                            |                            |
|----------------------------|----------------------------|
| 1. Tiller                  | 9. Seat Pivot Lever        |
| 2. Control Panel           | 10. Rug                    |
| 3. Tiller Adjustment Lever | 11. Front Bumper           |
| 4. Removable Seat          | 12. Headlight              |
| 5. Adjustable Armrest      | 13. Front Basket           |
| 6. Rear Light              | 14. Turn Signal            |
| 7. Free Wheel Lever        | 15. Seat Position Adjuster |
| 8. Anti-Tip Wheel          |                            |

## Batteries

Your scooter is equipped with maintenance free, sealed lead acid batteries. These batteries require no maintenance other than ensuring that they are properly charged. If other batteries are used, check with your battery supplier for proper battery care and maintenance instructions.

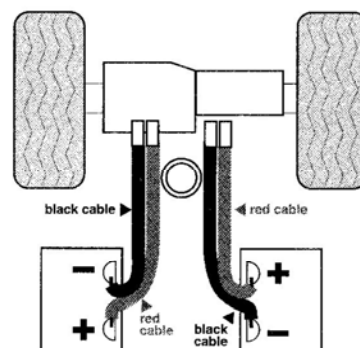

Your scooter comes supplied with two battery cables. Attach the red wire of the first cable to the (+) terminal of the first battery. Attach the black wire of the first cable to the (-) terminal of the first battery. Repeat this procedure for the second battery.

### ■ Charging the batteries

Note: because your batteries may only have a partial charge when you first receive your scooter, you may not experience full riding time until you have fully charged them. Your scooter is equipped with a battery charger. Charging your batteries as specified below will ensure maximum life, power and range.

## WARNING!

Use of a non-grounded receptacle could result in an electric shock

### Using On Board Charger

1. Turn off the power on the scooter.
2. Plug the charger cable into an outlet.
3. Plug the cable into the power socket at the rear of the scooter. (You will need to flip up the rubber safety covering on the power socket)
4. Leave the scooter to charge. As it charges, you will see progress lights in the clear circular window next to the charger socket. A RED light means the charger is ready to use, a WHITE light means charging is in progress, and a GREEN light means the charger is finished, and the scooter is fully charged.

### Using Off Board Charger

Follow steps 1 and 2 as above.

3. Plug the charger cable into the power socket on the tiller. (You will need to flip up the rubber safety covering on the power socket)
4. Leave the scooter to charge. As it charges, you will see progress lights on the charger unit. A RED light means the charger is ready to use, a WHITE light means charging is in progress, and a GREEN light means the charger is finished, and the scooter is fully charged.

## Parallel Tiller

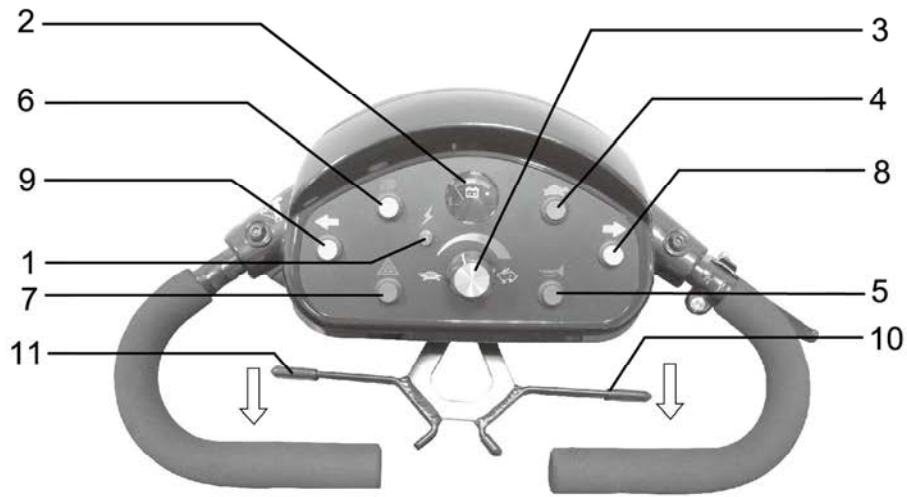

1. Status indicator
2. Battery condition meter
3. Speed adjustment dial
4. Half speed button
5. Horn
6. Light button
7. Hazard light button

8. Turn signal button (R)
9. Turn signal button (L)
10. Throttle control lever (forward)
11. Throttle control lever (backwards)
12. Key switch
13. Tiller angle adjustment lever
14. Off board charger receptacle



## ■ Controls (Digital dashboard)

Only drive within your control limitations. Loss of control of your scooter could result in serious injury to yourself or others. If your speed becomes difficult to control, release the speed lever and your scooter will come to a complete stop. Only use the on/off switch to stop your scooter in an emergency.

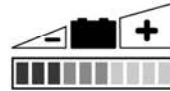
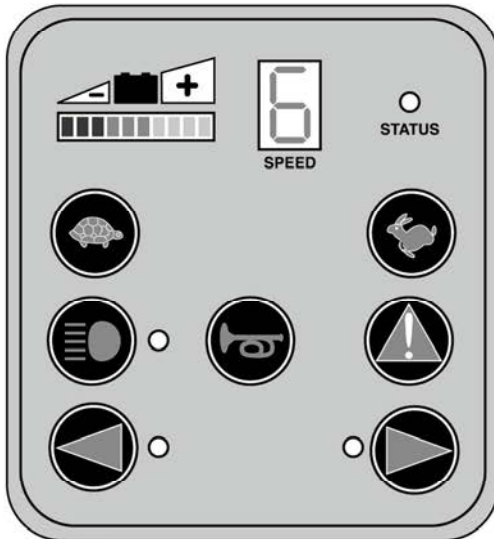

**Battery Level Indicator:** Indicates the charge level of the batteries. If only the red LEDs are on, the batteries need to be charged as soon as possible. If the LEDs are green, the batteries are fully charged. As the battery charge is depleted, the LEDs will go from green to yellow, and finally to red.



**Speed Control:** The speed on this scooter is controlled by the buttons on the control panel - one with a TURTLE makes the scooter slower, one with a RABBIT makes the scooter go faster. The speed has a range of 1 (slowest) to 6 (fastest) - each time you press the RABBIT or the TURTLE, it will either increase or decrease the speed 1 level. The current speed setting is shown on the LED indicator.



**Horn:** The horn is activated by pressing the horn button. Releasing the horn button deactivates the horn. The horn is useful to warn people or animals that you are coming towards them. You may also find it helpful to use when rounding blind corners.



**Turn Signals:** Pressing these buttons will activate the turn signal lights. The lights will automatically go off after 15 cycles.



**Headlight:** The headlight is activated by pressing the headlight button. Pressing the button a second time will turn the light off.



**Hazard Light:** The hazard lights are activated by pressing the hazard light button. Pressing the button a second time will turn the light off.

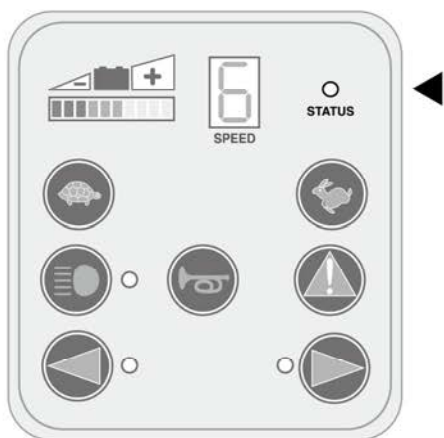

**Status Indicator:** When the scooter is on, and all conditions are normal, the Status Indicator will be on. When there is some special condition that needs attention, the light will flash. See the reference chart below for the meanings of the different flashing patterns.

Number of Flashes	Meaning
1	Battery needs recharging
2	Battery voltage too low
3	Battery voltage too high
4	Current time limit out
5	Brake fault
6	Not in neutral at power up
7	Speed pot error
8	Motor volts error
9	Other internal error

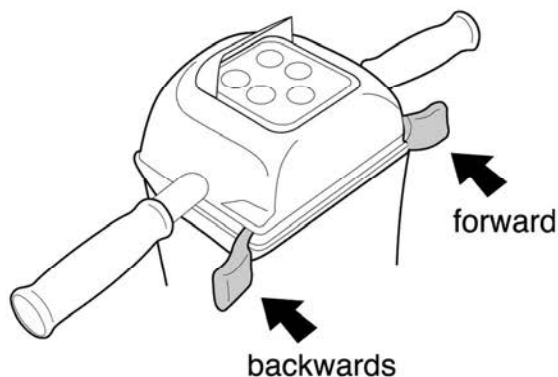

**Forward/Reverse:** Push the right lever to move forward, push the left lever to move backwards.

**Key Switch:** When the key is turned to a vertical position, the scooter is ON and ready to drive. When the key is horizontal, the scooter is OFF.

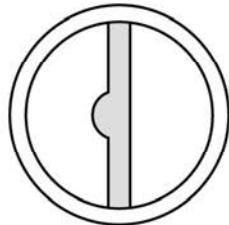

ON

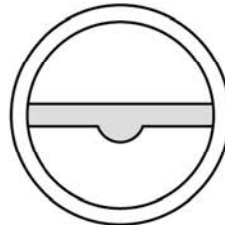

OFF

**Brakes and Throttle control lever:** Whenever the speed lever is pushed, the electromagnetic brake will automatically release and your scooter will move. When the speed lever is released, it will return to the neutral position and the scooter will decelerate and come to a complete stop. The parking brake will then engage preventing further movement of your scooter.

Your unit is equipped with a programmable controller that has a high peddle disable safety feature. This will prevent unexpected acceleration of the scooter, if the speed lever is being pushed at the same time you turn the key "ON". To reset the controller, release the speed engage lever and turn the key "OFF" for a couple of seconds and then turn it back "ON".



**If your scooter ever moves in an unexpected manner, release the speed lever and turn off the power.**

## ■ Controls (Analog dashboard)

Only drive within your control limitations. Loss of control of your scooter could result in serious injury to yourself or others. If your speed becomes difficult to control, release the speed engager lever and your scooter will come to a complete stop. **Only use the on/off switch to stop your scooter in an emergency.**

**1. Status Indicator:** When the scooter is on, and all conditions are normal, the Status Indicator will glow Green.

If there is a special condition that requires attention, the light will flash a code, which will be repeated after a 2 second pause. Please refer to the "Flash Code" chart below for the codes before contacting your.



- 1: Battery needs recharging
- 2: Battery voltage too low
- 3: Battery voltage too high
- 4: Current time limit out
- 5: Magnetic brake fault
- 6: Not in neutral at power up
- 7: Speed pot error
- 8: Motor volts error
- 9: Other internal error

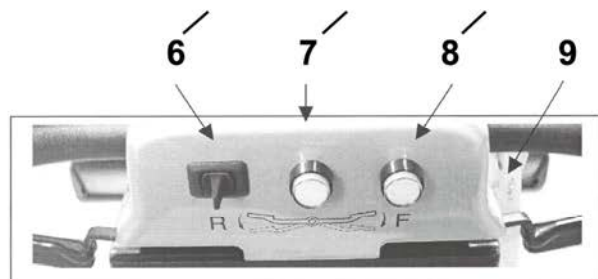

10  
Reverse Lever ← Throttle → Forward Lever  
(Half speed function is optional)

**2. Battery Level Indicator:** When power to the vehicle is turned "ON", the needle on this display will move to the right to indicate the available battery reserve. When the batteries are fully charged, the needle should be well into the green area of the display when the scooter is stationary. If the scooter is being driven at high power consumption levels (i.e. high speeds, up hills and/or with heavy loads) the needle will move progressively to the left and possibly into the red area. This situation is normal but this type of driving is not recommended for prolonged periods. The needle positioned in the red area of the scale when the scooter is stationary indicates very low battery reserves and the scooter should be recharged as soon as possible.

**3.Speed Control:**This knob set the maximum speed of the vehicle. When knob is rotated fully counter clockwise (4), input commands of the throttle levers (9)cause slower vehicle response and speed. As the knob is incrementally turned in a clockwise direction (5), the scooter will move faster for a given command. When learning to drive the vehicle or operating in confined areas, we strongly recommend that the control is set fully counter clockwise.

**4.Slow Speed:**Picture of Tortoise indicates slow setting of speed knob (5).

**5.Fast Speed:**Picture of Hare indicates fast setting of speed knob (5).

**6.Indicator Switch:**Left and right indicators can be operated by gently moving the toggle switch to the left (◀) or right (▶), as desired, if you wish to indicate that turning maneuver to others around you. To cancel the indicators simply return the toggle switch to the central position. You may draw the attention of others to your maneuver by tooting the horn once or twice.

**7.Headlight Switch:**The headlight is activated by gently pressing the headlight button in. The headlight can be turned off by gently pressing the switch again.

**8.Horn:**The horn is activated by pressing the horn button. Releasing the button deactivates the horn. The horn is useful to warn people or animals that you are approaching. You may also find it helpful to use when rounding blind corners.

**9.Half Speed Switch:**The Orange switch next to the ignition switch can be used to manually limit the scooter to a more manageable speed when traveling in confined areas. Gently press the switch to activate this function. A light will glow inside the switch to remind you it is on. Gently press the switch again to release the switch and deactivate this function. When driving at speed (as a safety feature), this function will activate automatically if the steering is turned.

**10.Throttle Levers:**With loop handlebar models, the throttle levers can be activated by finger or thumb, depending on personal preference. The throttle is progressive and can be used to regulate the speed up to the setting of the speed control knob (3).

**To travel forward:**gently pull the right lever back toward you with your right finger(s), or push the left lever away from you with your left thumb, until the desired speed is achieved.

**To travel backwards:**gently pull the left lever back toward you with your left finger(s), or push the right lever away from you with your right thumb, until the desired speed is achieved.

**NB:***(Polarity of the throttle can be reversed by your dealer if you require left hand finger operation to travel forward).*

## ■ Seat adjustment

### Backrest angle:

- Fold the backrest down for easy transport.



### Seat turnability

The seat swivel lever (located on the side of the seat) allows the seat rotation in 45 degree increments.

You may use this feature to make it easier to transfer in and out of the seat.

- Pull the swivel lever up to unlock and rotate the seat.
- Pivot the seat to the position you desire.
- Release the lever and try to turn the seat back and forth slightly allowing the lever to lock into position.



### Armrest height:

- Loosen the clamping nut at the rear of the handle.
- Turn the bolt in to lower the angle of the armrest to your desired angle.



### Armrest width:

- Locate the width clamping nut (follow the armrest support down to the base of the seat).
- Loosen the clamping nut by turning counterclockwise.
- Pull the armrest in or out to reach your desired position.
- Tighten the width clamping nut.

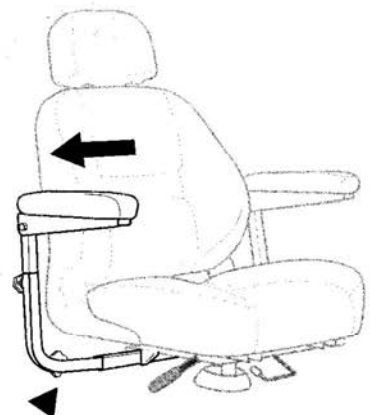

## ■ Tiller Angle Adjustment:

The tiller angle adjustment allows you to position the dash closer or further away from you for better access to the controls.

- Locate the angle adjusting lever where is located on the inside center of the tiller boot.
- Hold the weight of the tiller with on hand and loosen the lever by pulling up the lever with the other hand. Pushing down will release the tiller locking mechanism, allowing you to move the tiller freely.
- Release the lever and try to move the tiller back an forth slightly allowing the lever to lock.

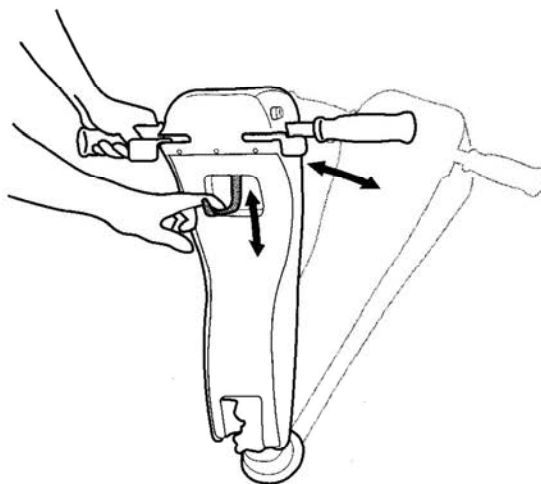

## ■ Freewheel Mode





Manul free wheel mode: your scooter features a features freewheel mode for manual operation. To activate manually, turn the key switch OFF and locate the freewheel lever at the back of the scooter. Pull lever to "UP" position to disengage the brake and allow the scooter to be pushed freely. Push the lever to the "DOWN" position to reengage the brrake. Remember, when the scooter is in manul freewheel mode, you will have mo brakes. You will be unable to operate the scooter. When you wish to push your scooter a short distance, you may put it into manual freewheel mode.

### Getting in and out:

Your scooter is designed to make getting in and out of the scooter as easy as possible. Make sure the scooter is on a level surface and the key switch is tuned OFF. If necessary, raise the armrest to give you maximum space to transfer in or out of the seat. Once transfer is complete, return the armrest before operating the scooter.



Never operate the scooter without your feet being placed on the scooter platform. Driving your scooter without your feet on the platform could cause serious bodily injury.

ICE SYMBOLS	
	<b>Caution, attention or consult accompanying documents.</b>
	<b>Alternating Current</b>
	<b>Type BF Equipment</b>
	<b>Double Insulation</b>
	<b>No Smoking or Naked Flames</b>

Degree of protection against ingress of water is rated as IPx0.



## Quick Reference Guide (S344B)

1. Tiller
2. Control Panel
3. Tiller Adjustment Lever
4. Removable Seat
5. Adjustable Armrest
6. Rear Light
7. Free Wheel Lever
8. Seat Pivot Lever
9. Rug
10. Front Bumper
11. Headlight
12. Front Basket
13. Turn Signal
14. Seat Position Adjuster

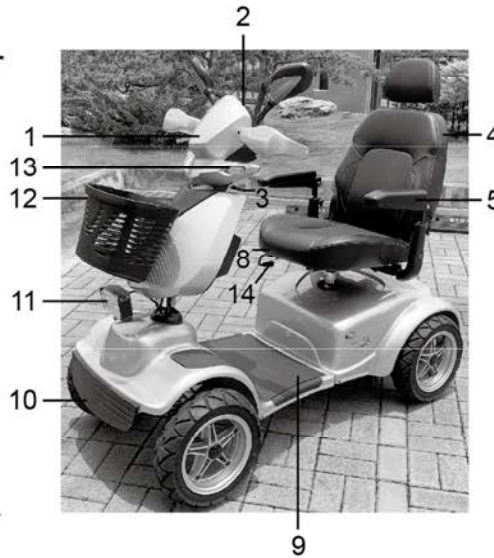

Model No.	S344B(4-Wheels)
Max. speed up to	12 kph / 7.5mph
Range Up To	50 km / 32 mi
Turning Radius	165 cm / 65 in
Ground Clearance	10 cm / 4 in
Motor	650W
Controller	Rhino II 160A
Battery	12V / grupop 24 x 2 PCS
Charger	6A Off-board
Gradient	8°
Front Wheel	14" x 4"
Rear Wheel	14" x 4"
Brake	Intelligent,regenerative and electromagnetic brakes
Overall Length	152 cm / 60 in
Overall Width	71 cm / 28"
Total Weight Without Batteries	105 kg / 231 lbs
Weight Capacity	227 kg / 500 lbs
Battery Weight	25 kg / 55 lb (each)

*This specification is for universal use and real spec may vary by regions and countries.  
Note : Depends on the specifications of the accompanied charger.*

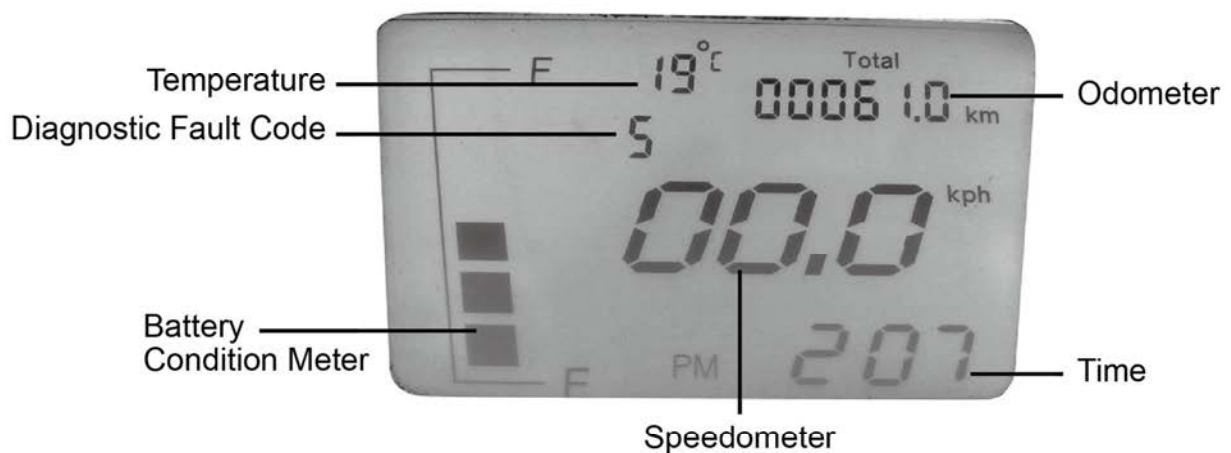
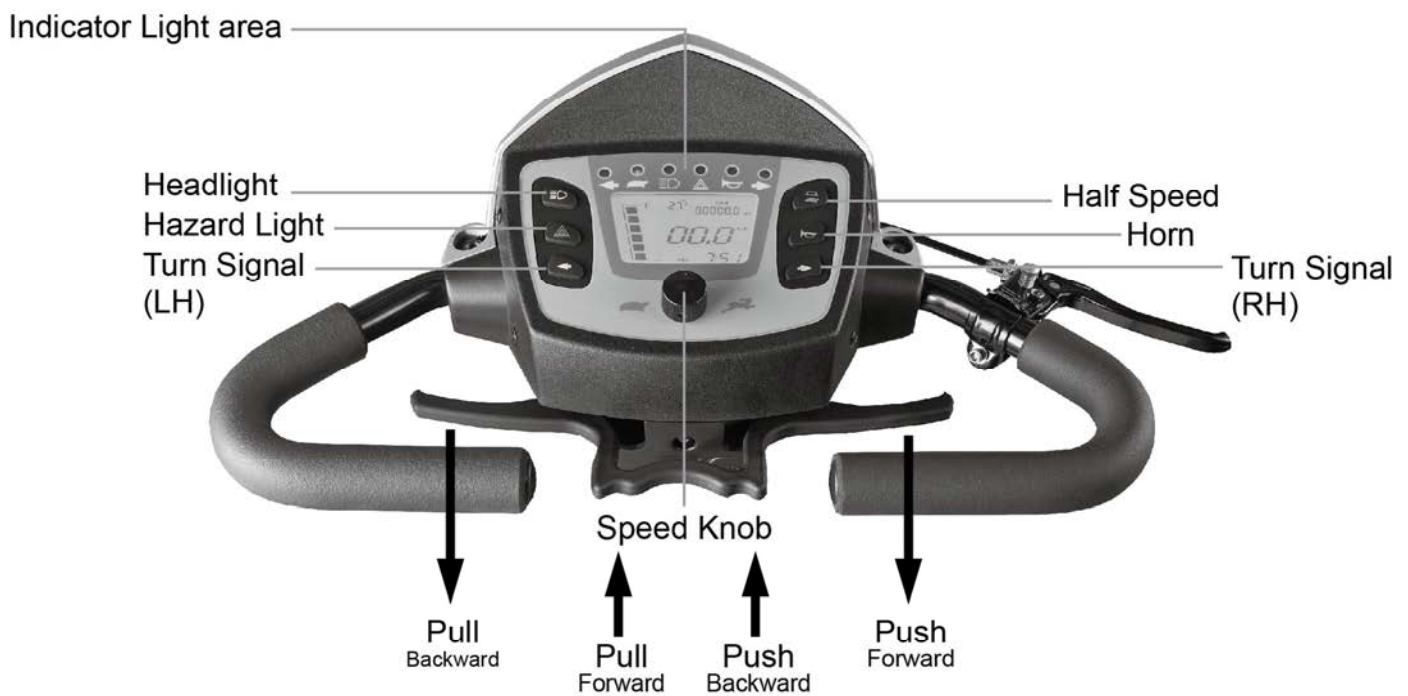
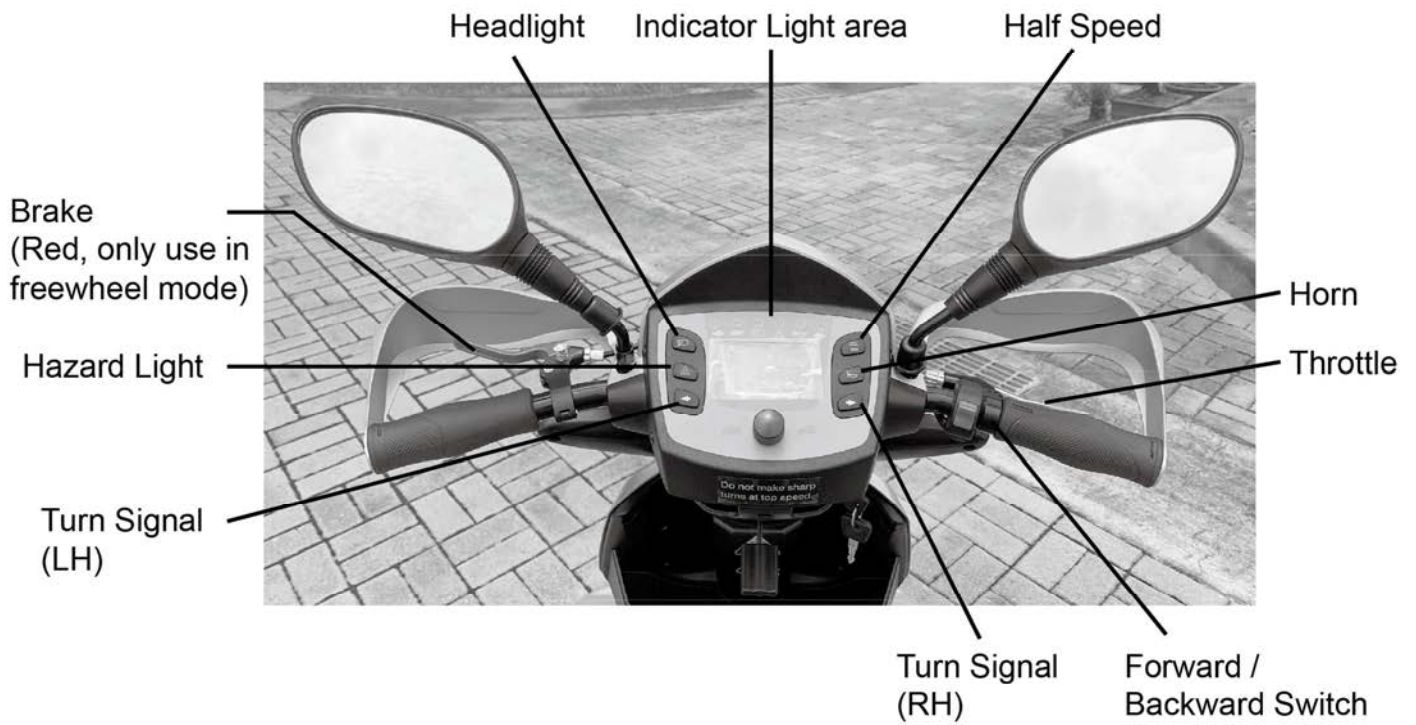

We wish you a safe and comfortable riding experience!





MedNet EC-REP GmbH  
Borkstrasse 10,  
48163 Muenster, Germany



**Manufacturer**

Merits Health Products Co., Ltd.  
No. 18, Jingke Road, T.P.M.T. Park, Nantun District, Taichung  
City 40852, Taiwan, R.O.C.